

Dell™ Inspiron™ 1010 Service Manual

[Before You Begin](#)

[Battery](#)

[Keyboard](#)

[Palm Rest](#)

[Hard Drive](#)

[Communication Cards](#)

[Palm Rest Bracket](#)

[Battery Status Light Board](#)

[Speakers](#)

[Internal Card With Bluetooth® Wireless Technology](#)

[Power Button Board](#)

[Coin-Cell Battery](#)

[2-in-1 Memory and Processor Board](#)

[3-in-1 Media Card Reader \(Daughter Board 1\)](#)

[TV Tuner Card \(Optional\)](#)

[USB and SIM Card Board \(Daughter Board 2\)](#)

[AC Adapter Connector](#)

[Display](#)

[System Board](#)

[Flashing the BIOS](#)

Notes, Cautions, and Warnings



NOTE: A NOTE indicates important information that helps you make better use of your computer.



CAUTION: A CAUTION indicates either potential damage to hardware or loss of data and tells you how to avoid the problem.



WARNING: A WARNING indicates a potential for property damage, personal injury, or death.

Information in this document is subject to change without notice.

© 2009 Dell Inc. All rights reserved.

Reproduction of these materials in any manner whatsoever without the written permission of Dell Inc. is strictly forbidden.

Trademarks used in this text: *Dell*, the *DELL* logo, and *Inspiron* are trademarks of Dell Inc.; *Bluetooth* is a registered trademark owned by Bluetooth SIG, Inc. and is used by Dell under license; *Microsoft*, *Windows*, *Windows Vista*, and *Windows Vista* start button logo are either trademarks or registered trademarks of Microsoft Corporation in the United States and/or other countries.

Other trademarks and trade names may be used in this document to refer to either the entities claiming the marks and names or their products. Dell Inc. disclaims any proprietary interest in trademarks and trade names other than its own.

Model PP19S

February 2009 Rev. A00

AC Adapter Connector

Dell™ Inspiron™ 1010 Service Manual

- [Removing the AC Adapter Connector](#)
- [Replacing the AC Adapter Connector](#)

- WARNING:** Before working inside your computer, read the safety information that shipped with your computer. For additional safety best practices information, see the Regulatory Compliance Homepage at www.dell.com/regulatory_compliance.
- CAUTION:** To avoid electrostatic discharge, ground yourself by using a wrist grounding strap or by periodically touching an unpainted metal surface.
- CAUTION:** Only a certified service technician should perform repairs on your computer. Damage due to servicing that is not authorized by Dell™ is not covered by your warranty.
- CAUTION:** To help prevent damage to the system board, remove the main battery (see [Removing the Battery](#)) before working inside the computer.
-

Removing the AC Adapter Connector

1. Follow the instructions in [Before You Begin](#).
2. Remove the battery (see [Removing the Battery](#)).
3. Remove the keyboard (see [Removing the Keyboard](#)).
4. Remove the palm rest (see [Removing the Palm Rest](#)).
5. Remove the hard drive (see [Removing the Hard Drive](#)).
6. Remove the palm rest bracket (see [Removing the Palm Rest Bracket](#)).
7. Remove the USB and SIM card board (see [Removing the USB and SIM Card Board](#)).
8. Disconnect the AC adapter cable from the system board connector.
9. Remove the AC adapter connector bracket.
10. Slide the AC adapter cable connector out of the computer base.

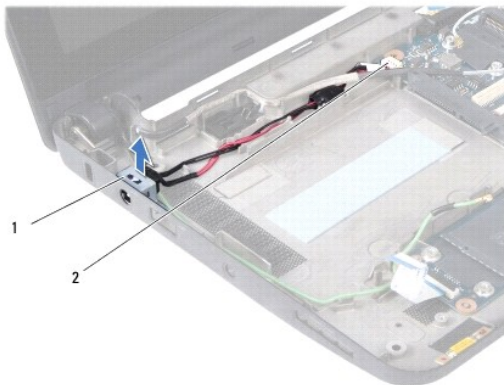

1	AC adapter connector bracket	2	system board connector
---	------------------------------	---	------------------------

Replacing the AC Adapter Connector

1. Place the AC adapter cable connector on the system board.

2. Replace the AC adapter connector bracket.
 3. Connect the AC adapter cable to the system board connector.
 4. Replace the USB and SIM card board (see [Replacing the USB and SIM Card Board](#)).
 5. Replace the palm rest bracket (see [Replacing the Palm Rest Bracket](#)).
 6. Replace the hard drive (see [Replacing the Hard Drive](#)).
 7. Replace the palm rest (see [Replacing the Palm Rest](#)).
 8. Replace the keyboard (see [Replacing the Keyboard](#)).
 9. Replace the battery (see [Replacing the Battery](#)).
-

[Back to Contents Page](#)

Battery Status Light Board

Dell™ Inspiron™ 1010 Service Manual

- [Removing the Battery Status Light Board](#)
- [Replacing the Battery Status Light Board](#)

- ⚠ WARNING:** Before working inside your computer, read the safety information that shipped with your computer. For additional safety best practices information, see the Regulatory Compliance Homepage at www.dell.com/regulatory_compliance.
- ⚠ CAUTION:** To avoid electrostatic discharge, ground yourself by using a wrist grounding strap or by periodically touching an unpainted metal surface.
- ⚠ CAUTION:** Only a certified service technician should perform repairs on your computer. Damage due to servicing that is not authorized by Dell™ is not covered by your warranty.
- ⚠ CAUTION:** To help prevent damage to the system board, remove the main battery (see [Removing the Battery](#)) before working inside the computer.
-

Removing the Battery Status Light Board

1. Follow the instructions in [Before You Begin](#).
2. Remove the battery (see [Removing the Battery](#)).
3. Remove the keyboard (see [Removing the Keyboard](#)).
4. Remove the palm rest (see [Removing the Palm Rest](#)).
5. Remove the hard drive (see [Removing the Hard Drive](#)).
6. Remove the palm rest bracket (see [Removing the Palm Rest Bracket](#)).
7. Disconnect the battery status light board cable from the system board connector.
8. Lift the battery status light board off the computer base.

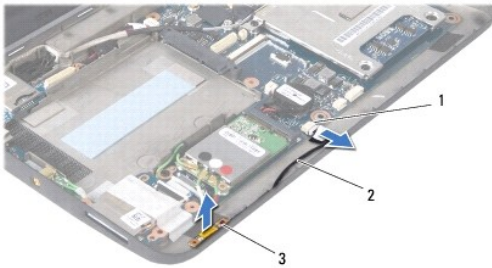

1	battery status light board cable connector	2	battery status light board cable
3	battery status light board		

Replacing the Battery Status Light Board

1. Replace the battery status light board on the computer base.
2. Connect the battery status light board cable to the system board connector.
3. Replace the palm rest bracket (see [Replacing the Palm Rest Bracket](#)).
4. Replace the hard drive (see [Replacing the Hard Drive](#)).

5. Replace the palm rest (see [Replacing the Palm Rest](#)).
6. Replace the keyboard (see [Replacing the Keyboard](#)).
7. Replace the battery (see [Replacing the Battery](#)).

[Back to Contents Page](#)

[Back to Contents Page](#)

Before You Begin

Dell™ Inspiron™ 1010 Service Manual

- [Recommended Tools](#)
- [Turning Off Your Computer](#)
- [Before Working Inside Your Computer](#)

This section provides procedures for removing and installing the components in your computer. Unless otherwise noted, each procedure assumes that the following conditions exist:

- 1 You have performed the steps in [Turning Off Your Computer](#) and [Before Working Inside Your Computer](#).
- 1 You have read the safety information that shipped with your computer.
- 1 A component can be replaced or—if purchased separately—installed by performing the removal procedure in the reverse order.

Recommended Tools

The procedures in this document may require the following tools:

- 1 Small flat-blade screwdriver
- 1 Phillips screwdriver
- 1 Plastic scribe
- 1 BIOS upgrade CD or the BIOS executable update program available on the Dell Support website at support.dell.com

Turning Off Your Computer

 **CAUTION:** To avoid losing data, save and close all open files and exit all open programs before you turn off your computer.

1. Save and close all open files and exit all open programs.
2. Shut down the operating system:

Microsoft® Windows® Vista:

Click **Start** , click the arrow , and then click **Shut Down**.

Ubuntu® Dell Desktop:

Click  → **Quit**  → **Shut down**.

Ubuntu Classic Desktop:

Click  → **Shut down**.

3. Ensure that the computer and all attached devices are turned off. If your computer and attached devices did not automatically turn off when you shut down your operating system, press and hold the power button until the computer turns off.

Before Working Inside Your Computer

Use the following safety guidelines to help protect your computer from potential damage and to help to ensure your own personal safety.

 **WARNING:** Before working inside your computer, read the safety information that shipped with your computer. For additional safety best practices information, see the Regulatory Compliance Homepage at www.dell.com/regulatory_compliance.

 **CAUTION:** Handle components and cards with care. Do not touch the components or contacts on a card. Hold a card by its edges or by its metal mounting bracket. Hold a component such as a processor by its edges, not by its pins.

 **CAUTION:** Only a certified service technician should perform repairs on your computer. Damage due to servicing that is not authorized by Dell is not covered by your warranty.

 **CAUTION:** When you disconnect a cable, pull on its connector or on its pull-tab, not on the cable itself. Some cables have connectors with locking tabs; if you are disconnecting this type of cable, press in on the locking tabs before you disconnect the cable. As you pull connectors apart, keep

them evenly aligned to avoid bending any connector pins. Also, before you connect a cable, ensure that both connectors are correctly oriented and aligned.

 **CAUTION:** To avoid damaging the computer, perform the following steps before you begin working inside the computer.

1. Ensure that the work surface is flat and clean to prevent the computer cover from being scratched.
2. Turn off your computer. See [Turning Off Your Computer](#).

 **CAUTION:** To disconnect a network cable, first unplug the cable from your computer and then unplug the cable from the network device.

3. Disconnect all telephone or network cables from the computer.
4. Press and eject any installed cards from the Memory Card Reader.
5. Disconnect your computer and all attached devices from their electrical outlets.
6. Remove the battery (see [Removing the Battery](#)).
7. Turn the computer top-side up, open the display, and press the power button to ground the system board.

[Back to Contents Page](#)

Flashing the BIOS

Dell™ Inspiron™ 1010 Service Manual

- [Flashing the BIOS From a CD](#)
- [Flashing the BIOS From the Hard Drive](#)
- [Flashing the BIOS in Ubuntu](#)

If a BIOS-update program CD is provided with the new system board, flash the BIOS from the CD. If you do not have a BIOS-update program CD, flash the BIOS from the hard drive.

 **NOTE:** Your computer does not have an internal optical drive. Use an external optical drive or any external storage device for the procedures that involve discs.

Flashing the BIOS From a CD

1. Ensure that the AC adapter is plugged in and that the main battery is installed properly.

 **NOTE:** If you use a BIOS-update program CD to flash the BIOS, set up the computer to boot from a CD before inserting the CD.

2. Insert the BIOS-update program CD, and restart the computer.

Follow the instructions that appear on the screen. The computer continues to boot and updates the new BIOS. When the flash update is complete, the computer will automatically restart.

3. Press <F2> during POST to enter the system setup program.
 4. Press <F9> to reset the computer defaults.
 5. Press <Esc>, select **Save changes and reboot**, and press <Enter> to save configuration changes.
 6. Remove the BIOS-update program CD from the drive and restart the computer.
-

Flashing the BIOS From the Hard Drive

1. Ensure that the AC adapter is plugged in, the main battery is properly installed, and a network cable is attached.
 2. Turn on the computer.
 3. Locate the latest BIOS update file for your computer at support.dell.com.
 4. Click **Download Now** to download the file.
 5. If the **Export Compliance Disclaimer** window appears, click **Yes, I Accept this Agreement**.
The **File Download** window appears.
 6. Click **Save this program to disk** and then click **OK**.
The **Save In** window appears.
 7. Click the down arrow to view the **Save In** menu, select **Desktop**, and then click **Save**.
The file downloads to your desktop.
 8. Click **Close** if the **Download Complete** window appears.
The file icon appears on your desktop and is titled the same as the downloaded BIOS update file.
 9. Double-click the file icon on the desktop and follow the instructions on the screen.
-

Flashing the BIOS in Ubuntu

1. Ensure that the AC adapter is plugged in, the main battery is properly installed, and a network cable is attached.
 2. Turn on the computer.
 3. Select  → **Places** → **Documents**.
 4. Create a new folder and name it **BIOS**.
 5. Locate the latest BIOS update file for your computer at support.dell.com.
 6. Click **Download Now** to download the file.
 7. If the **Export Compliance Disclaimer** window appears, click **Yes, I Accept this Agreement**.
The **File Download** window appears.
 8. Click **Save this program to disk** and then click **OK**.
The **Save In** window appears.
 9. Click the down arrow to view the **Save In** menu, select **Documents** → **BIOS**, and then click **Save**.
 10. Click **Close** if the **Download Complete** window appears.
The file icon appears on your BIOS folder and is titled the same as the downloaded BIOS update file.
 11. Open the terminal command line application and proceed as follows:
 - a. Type `sudo -s`
 - b. Type your password
 - c. Type `cd Documents`
 - d. Type `cd BIOS`
 - e. Type `./1210a00`

`flash start...` string appears.The computer will restart automatically once the BIOS flash is complete.
-

[Back to Contents Page](#)

[Back to Contents Page](#)

Internal Card With Bluetooth® Wireless Technology

Dell™ Inspiron™ 1010 Service Manual

- [Removing the Bluetooth Card](#)
- [Replacing the Bluetooth Card](#)

WARNING: Before working inside your computer, read the safety information that shipped with your computer. For additional safety best practices information, see the Regulatory Compliance Homepage at www.dell.com/regulatory_compliance.

CAUTION: To avoid electrostatic discharge, ground yourself by using a wrist grounding strap or by periodically touching an unpainted metal surface.

CAUTION: Only a certified service technician should perform repairs on your computer. Damage due to servicing that is not authorized by Dell™ is not covered by your warranty.

CAUTION: To help prevent damage to the system board, remove the main battery (see [Removing the Battery](#)) before working inside the computer.

If you ordered a card with Bluetooth wireless technology with your computer, it is already installed.

Removing the Bluetooth Card

1. Follow the instructions in [Before You Begin](#).
2. Remove the battery (see [Removing the Battery](#)).
3. Remove the keyboard (see [Removing the Keyboard](#)).
4. Remove the palm rest (see [Removing the Palm Rest](#)).
5. Remove the hard drive (see [Removing the Hard Drive](#)).
6. Remove the palm rest bracket (see [Removing the Palm Rest Bracket](#)).
7. Turn the palm rest bracket over.
8. While pulling the edge of the bluetooth card compartment push the bluetooth card out of the compartment as show in the figure.

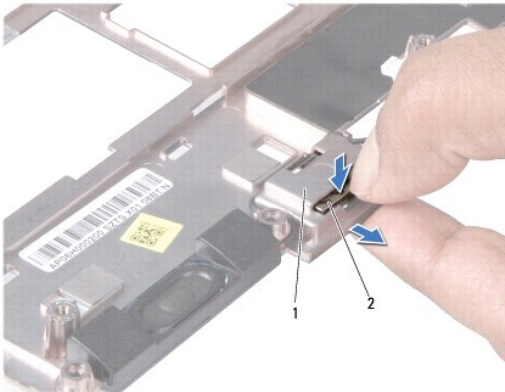

1	bluetooth card compartment	2	bluetooth card
---	----------------------------	---	----------------

Replacing the Bluetooth Card

1. Place the card in the bluetooth card compartment and snap it into place
2. Replace the palm rest bracket (see [Replacing the Palm Rest Bracket](#)).

3. Replace the hard drive (see [Replacing the Hard Drive](#)).
 4. Replace the palm rest (see [Replacing the Palm Rest](#)).
 5. Replace the keyboard (see [Replacing the Keyboard](#)).
 6. Replace the battery (see [Replacing the Battery](#)).
-

[Back to Contents Page](#)

[Back to Contents Page](#)

Coin-Cell Battery

Dell™ Inspiron™ 1010 Service Manual

- [Removing the Coin-Cell Battery](#)
- [Replacing the Coin-Cell Battery](#)

- WARNING:** Before working inside your computer, read the safety information that shipped with your computer. For additional safety best practices information, see the Regulatory Compliance Homepage at www.dell.com/regulatory_compliance.
- CAUTION:** To avoid electrostatic discharge, ground yourself by using a wrist grounding strap or by periodically touching an unpainted metal surface.
- CAUTION:** Only a certified service technician should perform repairs on your computer. Damage due to servicing that is not authorized by Dell™ is not covered by your warranty.
- CAUTION:** To help prevent damage to the system board, remove the main battery (see [Removing the Battery](#)) before working inside the computer.
-

Removing the Coin-Cell Battery

1. Follow the instructions in [Before You Begin](#).
2. Remove the battery (see [Removing the Battery](#)).
3. Remove the keyboard (see [Removing the Keyboard](#)).
4. Remove the palm rest (see [Removing the Palm Rest](#)).
5. Remove the hard drive (see [Removing the Hard Drive](#)).
6. Remove the palm rest bracket (see [Removing the Palm Rest Bracket](#)).
7. Disconnect the coin-cell battery cable from the system board connector.

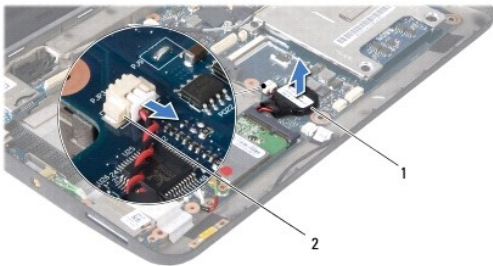

1	coin-cell battery	2	coin-cell battery cable connector
---	-------------------	---	-----------------------------------

8. Lift the coin-cell battery off the computer base.
-

Replacing the Coin-Cell Battery

1. Replace the coin-cell battery.
2. Connect the coin-cell battery cable to the system board connector.
3. Replace the palm rest bracket (see [Replacing the Palm Rest Bracket](#)).
4. Replace the hard drive (see [Replacing the Hard Drive](#)).
5. Replace the palm rest (see [Replacing the Palm Rest](#)).

6. Replace the keyboard (see [Replacing the Keyboard](#)).

7. Replace the battery (see [Replacing the Battery](#)).

[Back to Contents Page](#)

2-in-1 Memory and Processor Board

Dell™ Inspiron™ 1010 Service Manual

- [Removing the 2-in-1 Memory and Processor Board](#)
- [Replacing the 2-in-1 Memory and Processor Board](#)

- WARNING:** Before working inside your computer, read the safety information that shipped with your computer. For additional safety best practices information, see the Regulatory Compliance Homepage at www.dell.com/regulatory_compliance.
- CAUTION:** To avoid electrostatic discharge, ground yourself by using a wrist grounding strap or by periodically touching an unpainted metal surface.
- CAUTION:** Only a certified service technician should perform repairs on your computer. Damage due to servicing that is not authorized by Dell™ is not covered by your warranty.
- CAUTION:** To help prevent damage to the system board, remove the main battery (see [Removing the Battery](#)) before working inside the computer.
-

Removing the 2-in-1 Memory and Processor Board

1. Follow the instructions in [Before You Begin](#).
2. Remove the battery (see [Removing the Battery](#)).
3. Remove the keyboard (see [Removing the Keyboard](#)).
4. Remove the palm rest (see [Removing the Palm Rest](#)).
5. Remove the hard drive (see [Removing the Hard Drive](#)).
6. Remove the palm rest bracket (see [Removing the Palm Rest Bracket](#)).

CAUTION: When the 2-in-1 memory and processor board is removed from the computer, store it in protective antistatic packaging (see "Protecting Against Electrostatic Discharge" in the safety instructions that shipped with your computer).

7. Remove the four screws that secure the processor system board cover and the 2-in-1 memory and processor board to the system board.

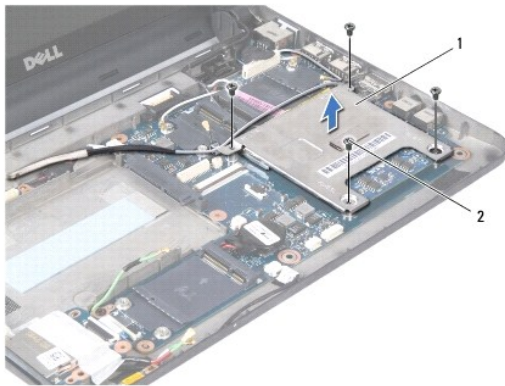

1	processor system board cover	2	screws (4)
---	------------------------------	---	------------

8. Remove the two thermal pads on the processor.

NOTE: The thermal pads may stick to the bottom of the processor system board cover. Remove the thermal pads from the bottom of the processor system board cover.

9. Use your fingertips to carefully spread apart the securing clips on either side of 2-in-1 memory and processor board connector until the board pops up.

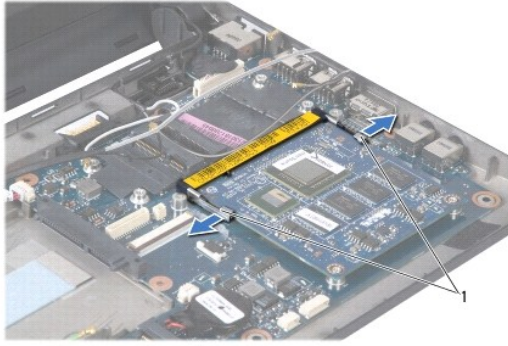

1	securing clips
---	----------------

10. Lift the 2-in-1 memory and processor board out of its system board connector.

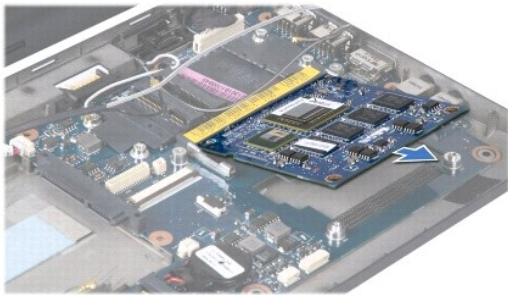

Replacing the 2-in-1 Memory and Processor Board

1. Align the notch in the 2-in-1 memory and processor edge connector with the tab in the connector slot.
2. Slide the 2-in-1 memory and processor board firmly into the slot at a 45-degree angle, and gently press the 2-in-1 memory and processor board down until it clicks into place. If you do not hear the click, remove the board and reinstall it.
3. Replace the processor system board cover on the 2-in-1 memory and processor board.
4. Replace the four screws that secure the processor system board cover and the 2-in-1 memory and processor board to the system board.
5. Replace the palm rest bracket (see [Replacing the Palm Rest Bracket](#)).
6. Replace the hard drive (see [Replacing the Hard Drive](#)).
7. Replace the palm rest (see [Replacing the Palm Rest](#)).
8. Replace the keyboard (see [Replacing the Keyboard](#)).
9. Replace the battery (see [Replacing the Battery](#)).

⚠ CAUTION: Before turning on the computer, replace all screws and ensure that no stray screws remain inside the computer. Failure to do so may result in damage to the computer.

10. Update the BIOS (see [Flashing the BIOS](#)).

Display

Dell™ Inspiron™ 1010 Service Manual

- [Removing the Display Assembly](#)
- [Replacing the Display Assembly](#)

- ⚠ WARNING:** Before working inside your computer, read the safety information that shipped with your computer. For additional safety best practices information, see the Regulatory Compliance Homepage at www.dell.com/regulatory_compliance.
- ⚠ CAUTION:** To avoid electrostatic discharge, ground yourself by using a wrist grounding strap or by periodically touching an unpainted metal surface.
- ⚠ CAUTION:** Only a certified service technician should perform repairs on your computer. Damage due to servicing that is not authorized by Dell™ is not covered by your warranty.
- ⚠ CAUTION:** To help prevent damage to the system board, remove the main battery (see [Removing the Battery](#)) before working inside the computer.
- ⚠ CAUTION:** To avoid damage to the display, you must not disassemble your Edge-to-Edge display assembly in the field.
-

Removing the Display Assembly

1. Follow the instructions in [Before You Begin](#).
2. Remove the battery (see [Removing the Battery](#)).
3. Remove the keyboard (see [Removing the Keyboard](#)).
4. Remove the palm rest (see [Removing the Palm Rest](#)).
5. Remove the hard drive (see [Removing the Hard Drive](#)).
6. Remove the palm rest bracket (see [Removing the Palm Rest Bracket](#)).
7. Disconnect the display cable from the system board connector.
8. Disconnect the Mini-Card cables from its connectors.
9. Make note of the Mini-Card cable routing and pull the Mini-Card cables out through the system board so that they are clear of the computer base.
10. Remove the 3-in-1 Media Card Reader (see [Removing the Media Card Reader](#)).

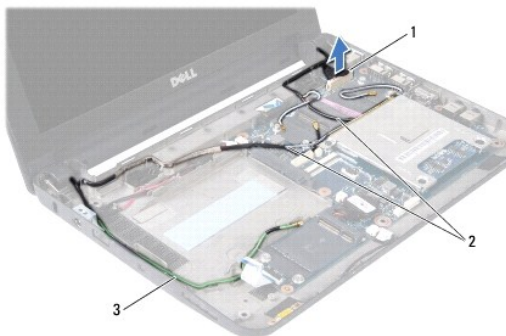

1	display cable connector	2	Mini-Card connector cables
3	TV tuner connector cables		

11. Disconnect the TV tuner cables from its connectors.
12. Remove the two screws that secure the display assembly to the computer base.

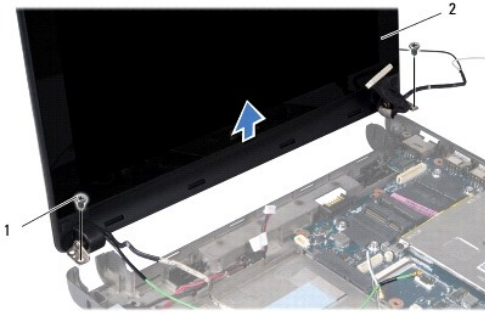

1	screws (2)	2	display assembly
---	------------	---	------------------

13. Lift and remove the display assembly from the computer base.

Replacing the Display Assembly

1. Place the display assembly in position and replace the two screws that secure the display assembly to the computer base.
 2. Connect the display cable to the system board connector.
 3. Route the Mini-Card cables and connect them to the Mini-Cards, if applicable (see [Replacing the Mini-Card](#)).
 4. Connect the TV tuner card cables to its connectors.
 5. Replace the 3-in-1 Media Card Reader (see [Replacing the Media Card Reader](#)).
 6. Replace the palm rest bracket (see [Replacing the Palm Rest Bracket](#)).
 7. Replace the hard drive (see [Replacing the Hard Drive](#)).
 8. Replace the palm rest (see [Replacing the Palm Rest](#)).
 9. Replace the keyboard (see [Replacing the Keyboard](#)).
 10. Replace the battery (see [Replacing the Battery](#)).
-

[Back to Contents Page](#)

3-in-1 Media Card Reader (Daughter Board 1)

Dell™ Inspiron™ 1010 Service Manual

- [Removing the Media Card Reader](#)
- [Replacing the Media Card Reader](#)

- WARNING:** Before working inside your computer, read the safety information that shipped with your computer. For additional safety best practices information, see the Regulatory Compliance Homepage at www.dell.com/regulatory_compliance.
- CAUTION:** To avoid electrostatic discharge, ground yourself by using a wrist grounding strap or by periodically touching an unpainted metal surface.
- CAUTION:** Only a certified service technician should perform repairs on your computer. Damage due to servicing that is not authorized by Dell™ is not covered by your warranty.
- CAUTION:** To help prevent damage to the system board, remove the main battery (see [Removing the Battery](#)) before working inside the computer.
-

Removing the Media Card Reader

1. Follow the instructions in [Before You Begin](#).
2. Remove the battery (see [Removing the Battery](#)).
3. Remove the keyboard (see [Removing the Keyboard](#)).
4. Remove the palm rest (see [Removing the Palm Rest](#)).
5. Remove the hard drive (see [Removing the Hard Drive](#)).
6. Remove the palm rest bracket (see [Removing the Palm Rest Bracket](#)).
7. Pull the pull-tab to disconnect the Media Card Reader cable from the connector on the Media Card Reader.
8. Peel off the mylar tape which secures the Media Card Reader to the computer base.

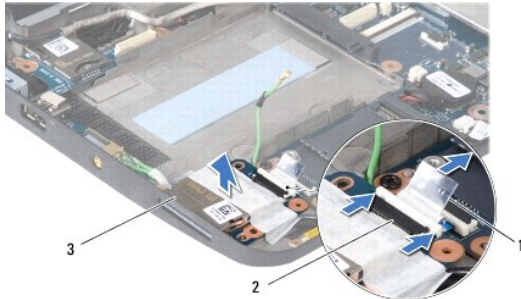

1	pull-tab	2	Media Card Reader cable connector
3	Media Card Reader		

9. Lift the Media Card Reader out of the computer base.
-

Replacing the Media Card Reader

1. Place the Media Card Reader on the computer base.
2. Connect the Media Card Reader cable to the Media Card Reader connector.
3. Fix the mylar tape back on the Media Card Reader.

4. Replace the palm rest bracket (see [Replacing the Palm Rest Bracket](#)).
 5. Replace the hard drive (see [Replacing the Hard Drive](#)).
 6. Replace the palm rest (see [Replacing the Palm Rest](#)).
 7. Replace the keyboard (see [Replacing the Keyboard](#)).
 8. Replace the battery (see [Replacing the Battery](#)).
-

[Back to Contents Page](#)

Hard Drive

Dell™ Inspiron™ 1010 Service Manual

- [Removing the Hard Drive](#)
- [Replacing the Hard Drive](#)

- ⚠ **WARNING:** If you remove the hard drive from the computer when the drive is hot, do not touch the metal housing of the hard drive.
 - ⚠ **WARNING:** Before working inside your computer, read the safety information that shipped with your computer. For additional safety best practices information, see the Regulatory Compliance Homepage at www.dell.com/regulatory_compliance.
 - ⚠ **CAUTION:** To prevent data loss, turn off your computer (see [Turning Off Your Computer](#)) before removing the hard drive. Do not remove the hard drive while the computer is On or in Sleep state.
 - ⚠ **CAUTION:** Hard drives are extremely fragile. Exercise care when handling the hard drive.
 - ⚠ **CAUTION:** Only a certified service technician should perform repairs on your computer. Damage due to servicing that is not authorized by Dell is not covered by your warranty.
 - ⚠ **CAUTION:** To help prevent damage to the system board, remove the main battery (see [Removing the Battery](#)) before working inside the computer.
 - 🔧 **NOTE:** Dell does not guarantee compatibility or provide support for hard drives from sources other than Dell.
 - 🔧 **NOTE:** If you are installing a hard drive from a source other than Dell, you need to install an operating system, drivers, and utilities on the new hard drive (see the *Dell Technology Guide*).
-

Removing the Hard Drive

1. Follow the procedures in [Before You Begin](#).
2. Remove the battery (see [Removing the Battery](#)).
3. Remove the keyboard (see [Removing the Keyboard](#)).

- ⚠ **CAUTION:** When the hard drive is not in the computer, store it in protective antistatic packaging (see "Protecting Against Electrostatic Discharge" in the safety instructions that shipped with your computer).

4. Remove the screw that secures the hard drive assembly to the computer base.



1	hard drive assembly	2	pull-tab	3	screw
---	---------------------	---	----------	---	-------

5. Pull the pull-tab towards the left to detach the hard drive assembly from the interposer.
6. Lift the hard drive assembly out of the hard drive compartment.
7. Remove the four screws that secure the hard drive bracket to the hard drive and remove the bracket.

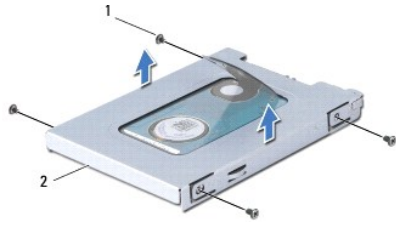

1	screws (4)	2	hard drive bracket
---	------------	---	--------------------

Replacing the Hard Drive

1. Remove the new hard drive from its packaging.

Save the original packaging for storing or shipping the hard drive.

2. Replace the hard drive bracket and the four screws that secure the bracket to the hard drive.
 3. Place the hard drive assembly in the hard drive compartment.
 4. Push the hard drive into the interposer until it is fully connected.
 5. Replace the screw that secures the hard drive assembly to the computer base.
 6. Replace the keyboard (see [Replacing the Keyboard](#)).
 7. Replace the battery (see [Replacing the Battery](#)).
 8. Install the operating system for your computer, as needed. See "Restoring Your Operating System" in the *Setup Guide* or *Ubuntu Quick Start Guide*.
 9. Install the drivers and utilities for your computer, as needed. See "Reinstalling Drivers and Utilities" in the *Dell Technology Guide*.
-

[Back to Contents Page](#)

[Back to Contents Page](#)

Keyboard

Dell™ Inspiron™ 1010 Service Manual

- [Removing the Keyboard](#)
- [Replacing the Keyboard](#)

- WARNING:** Before working inside your computer, read the safety information that shipped with your computer. For additional safety best practices information, see the Regulatory Compliance Homepage at www.dell.com/regulatory_compliance.
- CAUTION:** To avoid electrostatic discharge, ground yourself by using a wrist grounding strap or by periodically touching an unpainted metal surface.
- CAUTION:** Only a certified service technician should perform repairs on your computer. Damage due to servicing that is not authorized by Dell™ is not covered by your warranty.
- CAUTION:** To help prevent damage to the system board, remove the main battery (see [Removing the Battery](#)) before working inside the computer.
-

Removing the Keyboard

1. Follow the procedures in [Before You Begin](#).
2. Remove the battery (see [Removing the Battery](#)).
3. Remove the three screws that secure the keyboard to the computer base.



- CAUTION:** The keycaps on the keyboard are fragile, easily dislodged, and time-consuming to replace. Be careful when removing and handling the keyboard.
- CAUTION:** Be extremely careful when removing and handling the keyboard. Failure to do so could result in scratching the display panel.
4. Pry the center rear side of the keyboard by using your finger or flat-blade screwdriver. Slightly release the left side of the keyboard and then the right side till it comes out from its base.
 5. Ease the keyboard up until it clears off the palm rest bracket.
 6. Turn the keyboard over and place it over the palm rest.



1	keyboard tabs (4)
---	-------------------

7. Release the lock on the system board connector and pull the pull-tab to disconnect the keyboard cable from the system board connector.
8. Lift the keyboard off the palm rest.

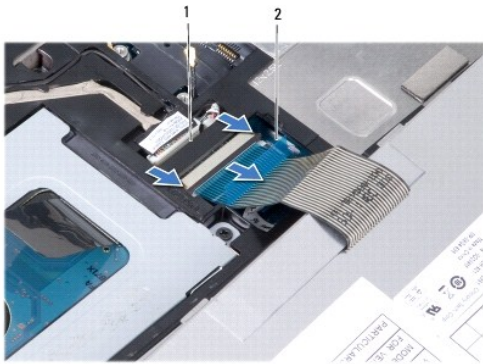

1	keyboard cable connector	2	pull-tab
---	--------------------------	---	----------

Replacing the Keyboard

1. Place the keyboard on the palm rest bracket.
2. Connect the keyboard cable to the system board connector.
3. Align the keyboard, insert the four tabs into the slots and fit the left side of the keyboard into place, and then snap the right side of the keyboard into place.
4. Turn the computer over and replace the three screws that secure the keyboard to the computer base.

[Back to Contents Page](#)

Communication Cards

Dell™ Inspiron™ 1010 Service Manual

- [Subscriber Identity Module](#)
- [Wireless Mini-Cards](#)

Subscriber Identity Module

Subscriber Identity Module (SIM) identify users uniquely through an International Mobile Subscriber Identity card.

WARNING: Before working inside your computer, read the safety information that shipped with your computer. For additional safety best practices information, see the Regulatory Compliance Homepage at www.dell.com/regulatory_compliance.

Installing the SIM

1. Follow the instructions in [Before You Begin](#).
2. Remove the battery (see [Removing the Battery](#)).
3. In the battery bay, slide the SIM into the compartment.



1	battery bay	2	SIM
---	-------------	---	-----

Removing the SIM

Press the SIM into the compartment to release it. When it is partially ejected, remove the SIM from the battery bay.

Wireless Mini-Cards

WARNING: Before working inside your computer, read the safety information that shipped with your computer. For additional safety best practices information, see the Regulatory Compliance Homepage at www.dell.com/regulatory_compliance.

CAUTION: To avoid electrostatic discharge, ground yourself by using a wrist grounding strap or by periodically touching an unpainted metal surface.

CAUTION: Only a certified service technician should perform repairs on your computer. Damage due to servicing that is not authorized by Dell™ is not covered by your warranty.

CAUTION: To help prevent damage to the system board, remove the main battery (see [Removing the Battery](#)) before working inside the computer.

NOTE: Dell does not guarantee compatibility or provide support for Mini-Cards from sources other than Dell.

If you ordered a wireless Mini-Card with your computer, the card is already installed.

Your computer supports two Mini-Card slots:

- 1 One full Mini-Card slot - for Mobile Broadband or WWAN
- 1 One half Mini-Card slot - for WLAN

NOTE: Depending on the configuration of the computer when it was sold, the Mini-Card slots may or may not have Mini-Cards installed in them.

Your computer supports two types of wireless Mini-Cards:

- 1 Wireless Local Area Network (WLAN)

Removing the Mini-Card

1. Follow the instructions in [Before You Begin](#).
2. Remove the battery (see [Removing the Battery](#)).
3. Remove the keyboard (see [Removing the Keyboard](#)).
4. Disconnect the antenna cables from the Mini-Card.

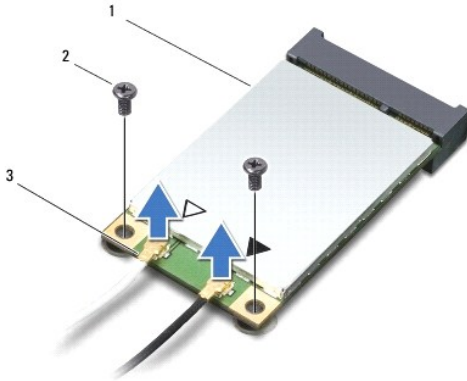

1	Mini-Card	2	screws (2)	3	antenna cable connector (2)
---	-----------	---	------------	---	-----------------------------

5. Release the Mini-Card by removing the two screws that secure the Mini-Card to the system board.
6. Lift the Mini-Card out of its system board connector.

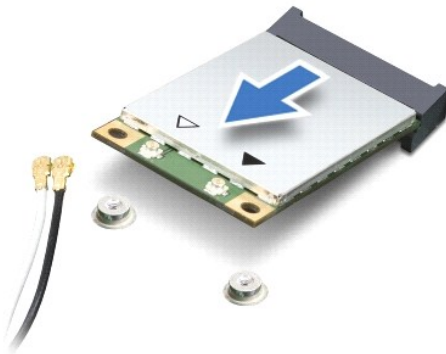

CAUTION: When the Mini-Card is not in the computer, store it in protective antistatic packaging (see "Protecting Against Electrostatic Discharge" in the safety instructions that shipped with your computer).

Replacing the Mini-Card

- CAUTION:** The connectors are keyed to ensure correct insertion. If you feel resistance, check the connectors on the card and on the system board, and realign the card.
- CAUTION:** To avoid damage to the Mini-Card, never place cables under the card.

1. Remove the new Mini-Card from its packing.

 **CAUTION:** Use firm and even pressure to slide the card into place. If you use excessive force, you may damage the connector.

2. Insert the Mini-Card at a 45-degree angle into the appropriate system board connector. For example, the WLAN card connector is labeled WLAN and so on.
3. Press the other end of the WLAN card down into the slot on the system board and replace the two securing screws.
4. Connect the appropriate antenna cables to the Mini-Card you are installing. The following table provides the antenna cable color scheme for each Mini-Card supported by your computer.

Connectors on the Mini-Card	Antenna Cable Color Scheme
WWAN (2 antenna cables)	
Main WWAN (white triangle)	white with gray stripe
Auxiliary WWAN (black triangle)	black with gray stripe
WLAN (2 antenna cables)	
Main WLAN (white triangle)	white
Auxiliary WLAN (black triangle)	black

5. Secure unused antenna cables in the protective mylar sleeve.
6. Replace the keyboard (see [Replacing the Keyboard](#)).
7. Replace the battery (see [Replacing the Battery](#)).
8. Install the drivers and utilities for your computer, as required. For more information, see the *Dell Technology Guide*.

 **NOTE:** If you are installing a communication card from a source other than Dell, you must install the appropriate drivers and utilities. For more generic driver information, see the *Dell Technology Guide*.

[Back to Contents Page](#)

[Back to Contents Page](#)

Palm Rest

Dell™ Inspiron™ 1010 Service Manual

- [Removing the Palm Rest](#)
- [Replacing the Palm Rest](#)

- WARNING:** Before working inside your computer, read the safety information that shipped with your computer. For additional safety best practices information, see the Regulatory Compliance Homepage at www.dell.com/regulatory_compliance.
- CAUTION:** To avoid electrostatic discharge, ground yourself by using a wrist grounding strap or by periodically touching an unpainted metal surface.
- CAUTION:** Only a certified service technician should perform repairs on your computer. Damage due to servicing that is not authorized by Dell™ is not covered by your warranty.
- CAUTION:** To help prevent damage to the system board, remove the main battery (see [Removing the Battery](#)) before working inside the computer.
-

Removing the Palm Rest

1. Follow the instructions in [Before You Begin](#).
2. Remove the battery (see [Removing the Battery](#)).
3. Remove keyboard (see [Removing the Keyboard](#)).
4. Remove the five screws from the bottom of the computer base.



5. Release the lock and disconnect the touch pad cable from the system board connector.



1	palm rest	2	touch pad cable connector
---	-----------	---	---------------------------

- CAUTION:** Carefully separate the palm rest from the computer base to avoid damage to the palm rest.

6. Starting at the right/left of the palm rest, use your fingers to separate the palm rest from the palm rest bracket.
 7. Gently pull the touch pad cable out of the cable slot and lift the palm rest off the palm rest bracket.
-

Replacing the Palm Rest

1. Route the touch pad cable through the cable slot and connect the cable to the system board connector.
 2. Align the palm rest on the palm rest bracket and gently snap the palm rest into place.
 3. Replace the five screws at the bottom of the computer base.
 4. Replace the keyboard (see [Replacing the Keyboard](#)).
 5. Replace the battery (see [Replacing the Battery](#)).
-

[Back to Contents Page](#)

Palm Rest Bracket

Dell™ Inspiron™ 1010 Service Manual

- [Removing the Palm Rest Bracket](#)
- [Replacing the Palm Rest Bracket](#)

- WARNING:** Before working inside your computer, read the safety information that shipped with your computer. For additional safety best practices information, see the Regulatory Compliance Homepage at www.dell.com/regulatory_compliance.
- CAUTION:** To avoid electrostatic discharge, ground yourself by using a wrist grounding strap or by periodically touching an unpainted metal surface.
- CAUTION:** Only a certified service technician should perform repairs on your computer. Damage due to servicing that is not authorized by Dell™ is not covered by your warranty.
- CAUTION:** To help prevent damage to the system board, remove the main battery (see [Removing the Battery](#)) before working inside the computer.
-

Removing the Palm Rest Bracket

1. Follow the instructions in [Before You Begin](#).
2. Remove the battery (see [Removing the Battery](#)).
3. Remove the keyboard (see [Removing the Keyboard](#)).
4. Remove the palm rest (see [Removing the Palm Rest](#)).
5. Remove the hard drive (see [Removing the Hard Drive](#)).
6. Disconnect the USB and SIM card cable, power button cable, bluetooth cable, and speaker cable from their respective system board connectors.

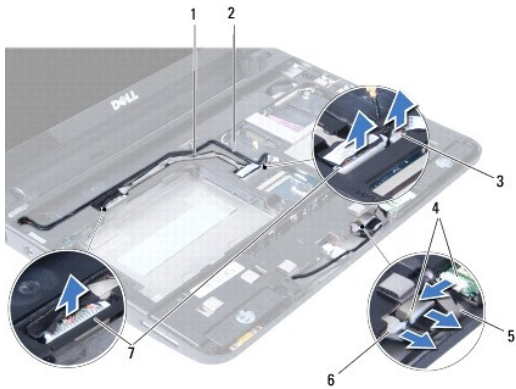

1	USB and SIM card cable	2	power button cable
3	power button cable connector	4	bluetooth cable connector
5	bluetooth cable	6	speaker cable connector
7	USB and SIM card cable connector		

7. Remove the two screws that secure the palm rest bracket to the computer base.

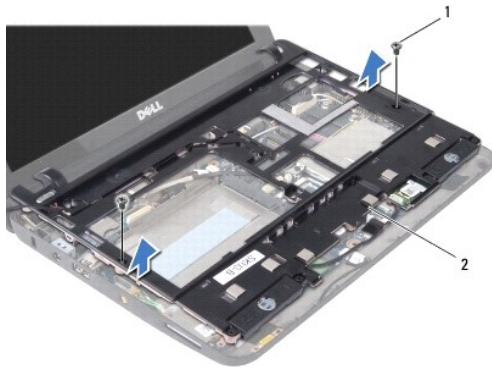

1	screws (2)	2	palm rest bracket
---	------------	---	-------------------

8. Lift the palm rest bracket off the computer base.
-

Replacing the Palm Rest Bracket

1. Place the palm rest bracket on the computer base.
 2. Replace the two screws that secure the bracket to the computer base.
 3. Connect the USB and SIM card cable, power button cable, bluetooth cable, and speaker cable to their respective system board connectors.
 4. Replace the hard drive (see [Replacing the Hard Drive](#)).
 5. Replace the palm rest (see [Replacing the Palm Rest](#)).
 6. Replace the keyboard (see [Replacing the Keyboard](#)).
 7. Replace the battery (see [Replacing the Battery](#)).
-

[Back to Contents Page](#)

Power Button Board

Dell™ Inspiron™ 1010 Service Manual

- [Removing the Power Button Board](#)
- [Replacing the Power Button Board](#)

- WARNING:** Before working inside your computer, read the safety information that shipped with your computer. For additional safety best practices information, see the Regulatory Compliance Homepage at www.dell.com/regulatory_compliance.
- CAUTION:** To avoid electrostatic discharge, ground yourself by using a wrist grounding strap or by periodically touching an unpainted metal surface.
- CAUTION:** Only a certified service technician should perform repairs on your computer. Damage due to servicing that is not authorized by Dell™ is not covered by your warranty.
- CAUTION:** To help prevent damage to the system board, remove the main battery (see [Removing the Battery](#)) before working inside the computer.
-

Removing the Power Button Board

1. Follow the instructions in [Before You Begin](#).
2. Remove the battery (see [Removing the Battery](#)).
3. Remove the keyboard (see [Removing the Keyboard](#)).
4. Remove the palm rest (see [Removing the Palm Rest](#)).
5. Remove the hard drive (see [Removing the Hard Drive](#)).
6. Remove the palm rest bracket (see [Removing the Palm Rest Bracket](#)).
7. Turn the palm rest bracket over and remove the screw that secures the power button board to the palm rest bracket.
8. Remove the power button cable from its routing.

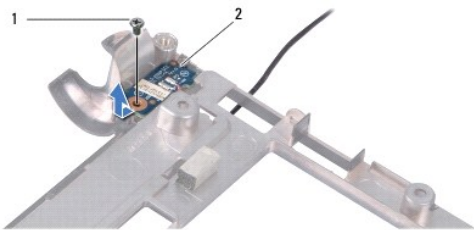

1	screw	2	power button board
---	-------	---	--------------------

9. Slide the power button board out of the palm rest bracket.
-

Replacing the Power Button Board

1. Place the power button board on the palm rest bracket.
2. Replace the screw that secures the power button board to the palm rest bracket.
3. Route the power button cable through its routing guide.
4. Replace the palm rest bracket (see [Replacing the Palm Rest Bracket](#)).
5. Replace the hard drive (see [Replacing the Hard Drive](#)).

6. Replace the palm rest (see [Replacing the Palm Rest](#)).
 7. Replace the keyboard (see [Replacing the Keyboard](#)).
 8. Replace the battery (see [Replacing the Battery](#)).
-

[Back to Contents Page](#)

Battery

Dell™ Inspiron™ 1010 Service Manual

- [Removing the Battery](#)
- [Replacing the Battery](#)

- WARNING:** Before working inside your computer, read the safety information that shipped with your computer. For additional safety best practices information, see the Regulatory Compliance Homepage at www.dell.com/regulatory_compliance.
- CAUTION:** To avoid electrostatic discharge, ground yourself by using a wrist grounding strap or by periodically touching an unpainted metal surface.
- CAUTION:** Only a certified service technician should perform repairs on your computer. Damage due to servicing that is not authorized by Dell™ is not covered by your warranty.
- CAUTION:** To help prevent damage to the system board, you must remove the battery from the battery bay before you begin working inside the computer.
-

Removing the Battery

1. Shut down the computer and turn it over.

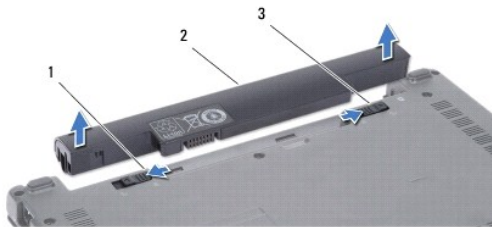

1	battery release latch	2	battery	3	battery lock latch
---	-----------------------	---	---------	---	--------------------

2. Slide the battery lock latch to unlock position.
 3. Slide the battery release latch to the side.
 4. Pull the battery up and out of the battery bay.
-

Replacing the Battery

- CAUTION:** To avoid damage to the computer, use only the battery designed for this particular Dell computer. Do not use batteries designed for other Dell computers.

1. Slide the battery in the battery bay until it clicks into place.
 2. Slide the battery lock latch to the lock position.
-

Speakers

Dell™ Inspiron™ 1010 Service Manual

- [Removing the Speakers](#)
- [Replacing the Speakers](#)

- WARNING:** Before working inside your computer, read the safety information that shipped with your computer. For additional safety best practices information, see the Regulatory Compliance Homepage at www.dell.com/regulatory_compliance.
- CAUTION:** To avoid electrostatic discharge, ground yourself by using a wrist grounding strap or by periodically touching an unpainted metal surface.
- CAUTION:** Only a certified service technician should perform repairs on your computer. Damage due to servicing that is not authorized by Dell™ is not covered by your warranty.
- CAUTION:** To help prevent damage to the system board, remove the main battery (see [Removing the Battery](#)) before working inside the computer.
-

Removing the Speakers

1. Follow the instructions in [Before You Begin](#).
2. Remove the battery (see [Removing the Battery](#)).
3. Remove the keyboard (see [Removing the Keyboard](#)).
4. Remove the palm rest (see [Removing the Palm Rest](#)).
5. Remove the hard drive (see [Removing the Hard Drive](#)).
6. Remove the palm rest bracket (see [Removing the Palm Rest Bracket](#)).

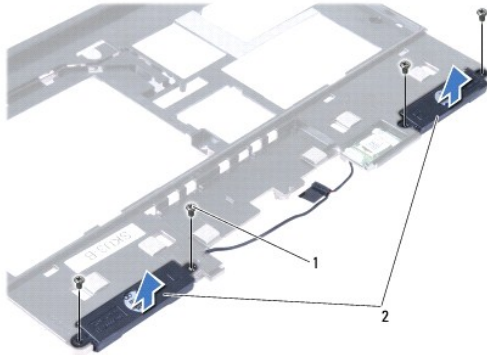

1	screws (4)	2	speakers
---	------------	---	----------

7. Turn over the palm rest bracket and remove the four screws (two on each side) that secure the speakers to the palm rest bracket.
 8. Lift the speakers off the palm rest bracket.
-

Replacing the Speakers

1. Place the speakers in the palm rest bracket and replace the four screws (two on each side) that secure the speakers to the palm rest bracket.
2. Replace the palm rest bracket (see [Replacing the Palm Rest Bracket](#)).
3. Replace the hard drive (see [Replacing the Hard Drive](#)).

4. Replace the palm rest (see [Replacing the Palm Rest](#)).
5. Replace the keyboard (see [Replacing the Keyboard](#)).
6. Replace the battery (see [Replacing the Battery](#)).

[Back to Contents Page](#)

[Back to Contents Page](#)

System Board

Dell™ Inspiron™ 1010 Service Manual

- [Removing the System Board](#)
- [Replacing the System Board](#)
- [Entering the Service Tag in the BIOS](#)
- [Setting the Keyboard Matrix](#)

- ⚠ WARNING:** Before working inside your computer, read the safety information that shipped with your computer. For additional safety best practices information, see the Regulatory Compliance Homepage at www.dell.com/regulatory_compliance.
- ⚠ CAUTION:** To avoid electrostatic discharge, ground yourself by using a wrist grounding strap or by periodically touching an unpainted metal surface.
- ⚠ CAUTION:** Only a certified service technician should perform repairs on your computer. Damage due to servicing that is not authorized by Dell™ is not covered by your warranty.
- ⚠ CAUTION:** To help prevent damage to the system board, remove the main battery (see [Removing the Battery](#)) before working inside the computer.
-

Removing the System Board

1. Follow the instructions in [Before You Begin](#).
2. Remove the battery (see [Removing the Battery](#)).
3. Remove the keyboard (see [Removing the Keyboard](#)).
4. Remove the palm rest (see [Removing the Palm Rest](#)).
5. Remove the hard drive (see [Removing the Hard Drive](#)).
6. Remove the palm rest bracket (see [Removing the Palm Rest Bracket](#)).
7. Remove the coin-cell battery (see [Removing the Coin-Cell Battery](#)).
8. Remove the 2-in-1 memory and processor board (see [Removing the 2-in-1 Memory and Processor Board](#)).
9. Remove the Mini-Cards (see [Removing the Mini-Card](#)).
10. Remove the TV tuner card (see [Removing the TV Tuner Card](#)).
11. Remove the 3-in-1 Media Card Reader (see [Removing the Media Card Reader](#)).
12. Remove the two screws that secure the system board to the computer base.

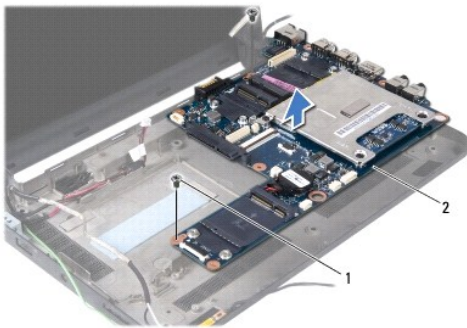

1	screws (2)	2	system board
---	------------	---	--------------

13. Lift the system board out of the computer base.

Replacing the System Board

1. Place the system board on the computer base.
2. Replace the two screws that secure the system board to the computer base.
3. Replace the 3-in-1 Media Card Reader (see [Replacing the Media Card Reader](#)).
4. Replace the TV tuner card (see [Replacing the TV Tuner Card](#)).
5. Replace the Mini-Cards (see [Replacing the Mini-Card](#)).
6. Replace the 2-in-1 processor and memory board (see [Replacing the 2-in-1 Memory and Processor Board](#)).
7. Replace the coin-cell battery (see [Replacing the Coin-Cell Battery](#)).
8. Replace the palm rest bracket (see [Replacing the Palm Rest Bracket](#)).
9. Replace the hard drive (see [Replacing the Hard Drive](#)).
10. Replace the palm rest (see [Replacing the Palm Rest](#)).
11. Replace the keyboard (see [Replacing the Keyboard](#)).
12. Replace the battery (see [Replacing the Battery](#)).

 **CAUTION:** Before turning on the computer, replace all screws and ensure that no stray screws remain inside the computer. Failure to do so may result in damage to the computer.

13. Turn on the computer.

 **NOTE:** After you have replaced the system board, enter the computer's Service Tag into the BIOS of the replacement system board.

14. Enter the service tag (see [Entering the Service Tag in the BIOS](#)).
 15. The keyboard matrix may change after you replace the system board. To set the keyboard matrix according to your country, see [Setting the Keyboard Matrix](#).
-

Entering the Service Tag in the BIOS

1. Ensure that the AC adapter is plugged in and that the main battery is installed properly.
 2. Press <F2> during POST to enter the system setup program.
 3. Navigate to the security tab and enter the service tag in the **Set Service Tag** field.
-

Setting the Keyboard Matrix

1. Turn off your computer (see [Turning Off Your Computer](#)).
2. If your computer is connected to the AC adapter, disconnect the AC adapter from the computer.
3. Press and hold the following key combination for the desired keyboard matrix:
 - o All countries except Brazil: <Fn><S>
 - o Brazil only: <Fn><E>
4. Connect the AC adapter to the computer and then plug it into a wall outlet or surge protector.

5. Release the key combination.

[Back to Contents Page](#)

[Back to Contents Page](#)

Dell™ Inspiron™ 1010 Service Manual



NOTE: A NOTE indicates important information that helps you make better use of your computer.



CAUTION: A CAUTION indicates either potential damage to hardware or loss of data and tells you how to avoid the problem.



WARNING: A WARNING indicates a potential for property damage, personal injury, or death.

Information in this document is subject to change without notice.
© 2009 Dell Inc. All rights reserved.

Reproduction of these materials in any manner whatsoever without the written permission of Dell Inc. is strictly forbidden.

Trademarks used in this text: *Dell*, the *DELL* logo, and *Inspiron* are trademarks of Dell Inc.; *Bluetooth* is a registered trademark owned by Bluetooth SIG, Inc. and is used by Dell under license; *Microsoft*, *Windows*, *Windows Vista*, and *Windows Vista* start button logo are either trademarks or registered trademarks of Microsoft Corporation in the United States and/or other countries.

Other trademarks and trade names may be used in this document to refer to either the entities claiming the marks and names or their products. Dell Inc. disclaims any proprietary interest in trademarks and trade names other than its own.

February 2009 Rev. A00

[Back to Contents Page](#)

[Back to Contents Page](#)

TV Tuner Card (Optional)

Dell™ Inspiron™ 1010 Service Manual

- [Removing the TV Tuner Card](#)
- [Replacing the TV Tuner Card](#)

- WARNING:** Before working inside your computer, read the safety information that shipped with your computer. For additional safety best practices information, see the Regulatory Compliance Homepage at www.dell.com/regulatory_compliance.
- CAUTION:** To avoid electrostatic discharge, ground yourself by using a wrist grounding strap or by periodically touching an unpainted metal surface.
- CAUTION:** Only a certified service technician should perform repairs on your computer. Damage due to servicing that is not authorized by Dell™ is not covered by your warranty.
- CAUTION:** To help prevent damage to the system board, remove the main battery (see [Removing the Battery](#)) before working inside the computer.
- NOTE:** The availability of the TV tuner card varies according to region.

Removing the TV Tuner Card

1. Follow the instructions in [Before You Begin](#).
2. Remove the battery (see [Removing the Battery](#)).
3. Remove the keyboard (see [Removing the Keyboard](#)).
4. Remove the palm rest (see [Removing the Palm Rest](#)).
5. Remove the hard drive (see [Removing the Hard Drive](#)).
6. Remove the palm rest bracket (see [Removing the Palm Rest Bracket](#)).
7. Remove the 3-in-1 Media Card Reader (see [Removing the Media Card Reader](#)).
8. Disconnect the three TV tuner card cables from the connectors on the TV tuner card.
9. Release the TV tuner card by removing the two screws that secure the card to the system board connector.

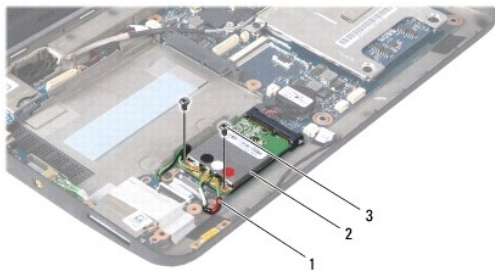

1	TV tuner card cables (3)	2	TV tuner card	3	screws (2)
---	--------------------------	---	---------------	---	------------

10. Lift the TV tuner card out of the system board connector.



11. Remove the screw that secures the TV tuner connector board.

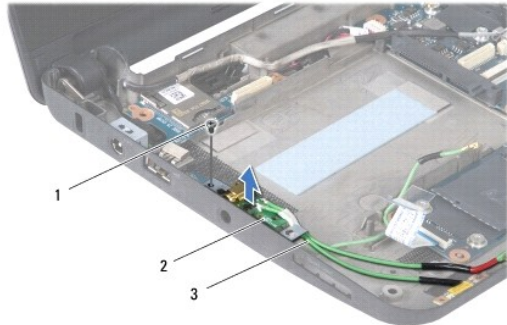

1	screw	2	TV tuner connector board	3	TV tuner connector cables
---	-------	---	--------------------------	---	---------------------------

12. Lift the TV tuner connector board off the computer base.

Replacing the TV Tuner Card

1. Remove the new TV tuner card from its packing.

⚠ CAUTION: Use firm and even pressure to slide the card into place. If you use excessive force, you may damage the connector.

2. Insert the TV tuner card at a 45-degree angle into the appropriate system board connector.

3. Press the other end of the TV tuner card down into the slot on the system board.

4. Replace the two screws that secure the TV tuner card to the system board.

5. Place the TV tuner connector board on the computer base and replace the screw that secures the TV tuner connector board to the computer base.

6. Connect the three TV tuner card cables to the connectors on the TV tuner card

7. Replace the 3-in-1 Media Card Reader (see [Replacing the Media Card Reader](#)).

8. Replace the palm rest bracket (see [Replacing the Palm Rest Bracket](#)).

9. Replace the hard drive (see [Replacing the Hard Drive](#)).

10. Replace the palm rest (see [Replacing the Palm Rest](#)).

11. Replace the keyboard (see [Replacing the Keyboard](#)).

12. Replace the battery (see [Replacing the Battery](#)).

USB and SIM Card Board (Daughter Board 2)

Dell™ Inspiron™ 1010 Service Manual

- [Removing the USB and SIM Card Board](#)
- [Replacing the USB and SIM Card Board](#)

- WARNING:** Before working inside your computer, read the safety information that shipped with your computer. For additional safety best practices information, see the Regulatory Compliance Homepage at www.dell.com/regulatory_compliance.
- CAUTION:** To avoid electrostatic discharge, ground yourself by using a wrist grounding strap or by periodically touching an unpainted metal surface.
- CAUTION:** Only a certified service technician should perform repairs on your computer. Damage due to servicing that is not authorized by Dell™ is not covered by your warranty.
- CAUTION:** To help prevent damage to the system board, remove the main battery (see [Removing the Battery](#)) before working inside the computer.
-

Removing the USB and SIM Card Board

1. Follow the instructions in [Before You Begin](#).
2. Remove the battery (see [Removing the Battery](#)).
3. Remove the keyboard (see [Removing the Keyboard](#)).
4. Remove the palm rest (see [Removing the Palm Rest](#)).
5. Remove the hard drive (see [Removing the Hard Drive](#)).
6. Remove the palm rest bracket (see [Removing the Palm Rest Bracket](#)).
7. Remove the three screws that secure the USB and SIM card board to the computer base.
8. Lift the USB and SIM card board out of the computer base.

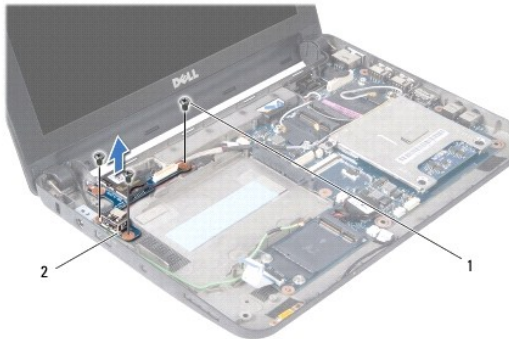

1	screws (3)	2	USB and SIM card board
---	------------	---	------------------------

Replacing the USB and SIM Card Board

1. Align the holes on the USB and SIM card board to the protrusions on the computer base.
2. Replace the three screws to secure the USB and SIM card board to the computer base.
3. Replace the palm rest bracket (see [Replacing the Palm Rest Bracket](#)).
4. Replace the hard drive (see [Replacing the Hard Drive](#)).

5. Replace the palm rest (see [Replacing the Palm Rest](#)).

6. Replace the keyboard (see [Replacing the Keyboard](#)).

7. Replace the battery (see [Replacing the Battery](#)).

[Back to Contents Page](#)